



---

P.O. Box 496 | Kingsburg, California 93631 | Office (559) 419-9481 | CA Lic. #913746 | [www.strategicindustry.us](http://www.strategicindustry.us)

## PROPOSAL OPTION #1

REFERENCE: BD23115

PROPOSAL DATED: May 10, 2023

Tulare Local Health Care District  
869 N Cherry St, PO BOX 1136  
Tulare, CA 93725

RE: Site Lighting expansion south Phase 2

---

### SCOPE OF WORK

#### Inclusions:

- Apply for and receive Underground 811
- Excavate trenching in order to install (2) new conduit raceways for site lighting from Phase 1 to pull box at pad mounted gear located south of building
- Provide and install (4) single head and (1) double head light pole per VE Specs that are attached
- Provide crane to place and install light poles on customer installed bases that are existing
- Backfill and compact exposed trenching

#### Exclusions:

- Any engineering of drawings
- Permits nor any fees involved with permitting
- Wiring in underground conduits
- Grading of site
- Any work not specifically listed above.

---

**COST PROPOSAL**

\*Material    \$    22,087.67  
  Labor         8,952.33

---

**\*\*TOTAL:    \$    31,040.00**

---

*\*All applicable sales tax is included.  
\*\*Proposal pricing is valid for 30 days from the date of this document.*

**CLIENT ACCEPTANCE:**

**STRATEGIC INDUSTRY, INC. CSLB #913746:**

---

Date

---

Date

---

Authorized Name and Title

---

Authorized Name and Title

---

Authorized Signature

---

Authorized Signature

## **TERMS AND CONDITIONS**

These Terms and Conditions are incorporated by reference and form an integral part of each proposal or agreement between STRATEGIC INDUSTRY, INC. ("STRATEGIC INDUSTRY") and the party for whom the Work is to be performed ("CLIENT"). The portions of each proposal or agreement relating to "Scope of Work" or "Proposed Solution" (in either case "Scope"), together with these Terms and Conditions, are collectively referred to as the "Agreement".

### **Article 1: General**

1.1 (a) The Agreement, when accepted in writing by CLIENT and approved by an authorized representative of STRATEGIC INDUSTRY, constitutes the entire, complete and exclusive agreement between the parties relating to the services ("Services") and the equipment ("Equipment") to be provided by STRATEGIC INDUSTRY as described in the Scope (such Services and Equipment collectively referred to as "Work") and shall supersede and cancel all prior agreements and understandings, written or oral, relating to the subject matter of the Agreement. The Agreement and any rights or obligations there under may not be assigned by either party without the prior written consent of the other, except that either party may assign this Agreement to its affiliates and STRATEGIC INDUSTRY may use subcontractors in the performance of the Work.

(b) The terms and conditions of this Agreement shall not be modified or rescinded except in writing, signed by a corporate officer of STRATEGIC INDUSTRY. STRATEGIC INDUSTRY performance under this Agreement is expressly conditioned on Client's assenting to all of the terms of this Agreement, notwithstanding any different or additional terms contained in any writing at any time submitted or to be submitted to STRATEGIC INDUSTRY by CLIENT relating to the Work.

(c) The terms and conditions set forth herein shall supersede, govern and control any conflicting terms of the Proposed Solution or the Proposal.

(d) Nothing contained in this Agreement shall be construed to give any rights or benefits to anyone other than the CLIENT and STRATEGIC INDUSTRY without the express written consent of both parties. All obligations arising prior to this Agreement and all provisions of this Agreement allocating responsibility or liability between the parties shall survive the completion of the Work and the termination of this Agreement.

1.2 This Agreement shall be governed by and enforced in accordance with the laws of the State of California. All claims or disputes arising under this Agreement shall be litigated in the State, Commonwealth, or Province in which Services are being provided to CLIENT hereunder.

### **Article 2: Work by STRATEGIC INDUSTRY**

2.1 STRATEGIC INDUSTRY will perform the Work expressly described in this Agreement and in any work release documents or change orders that are issued under this Agreement and signed by the parties. The Work performed by STRATEGIC INDUSTRY shall be conducted in a manner consistent with the degree of care and skill ordinarily exercised by reputable firms performing the same or similar Work in the same locale acting under similar circumstances and conditions.

2.2 STRATEGIC INDUSTRY shall perform the Work during its normal working hours, Monday through Friday, excluding holidays, unless otherwise agreed herein.

2.3 STRATEGIC INDUSTRY is not required to conduct safety or other tests, install new devices or equipment or make modifications to any Equipment beyond the Scope set forth in this Agreement. Any CLIENT request to change the Scope or the nature of the Work must be in the form of a mutually agreed change order, effective only when executed by all parties hereto.

2.4 All reports and drawings specifically prepared for and deliverable to CLIENT pursuant to this Agreement ("Deliverables") shall become CLIENT's property upon full payment to STRATEGIC INDUSTRY. STRATEGIC INDUSTRY may retain file copies of such deliverables. All other reports, notes, calculations, data, drawings, estimates, specifications, manuals, other documents and all computer programs, codes and computerized materials prepared by or for STRATEGIC INDUSTRY are instruments of STRATEGIC INDUSTRY work ("Instruments") and shall remain STRATEGIC INDUSTRY property. To the extent specified in the Scope, CLIENT, its employees and agents ("Permitted Users") shall have a right to make and retain copies of Instruments except uncompiled code, and to use all Instruments, provided however, the Instruments shall not be used or relied upon by any parties other than Permitted Users, and such use shall be limited to the particular project and location for which the Instruments were provided. All Deliverables and Instruments provided to CLIENT are for Permitted Users' use only for the purposes disclosed to STRATEGIC INDUSTRY, and CLIENT shall not transfer them to others or use them or permit them to be used for any extension of the Work or any other project or purpose, without STRATEGIC INDUSTRY's express written consent. Any reuse of Deliverables or Instruments for other projects or locations without the written consent of STRATEGIC INDUSTRY, or use by any party other than Permitted Users will be at Permitted Users' risk and without liability to STRATEGIC INDUSTRY; and CLIENT shall indemnify, defend and hold STRATEGIC INDUSTRY harmless from any claims, losses or damages arising there from.

2.5 STRATEGIC INDUSTRY shall be responsible for any portion of the Work performed by any subcontractor of STRATEGIC INDUSTRY. STRATEGIC INDUSTRY shall not have any responsibility, duty or authority to direct, supervise or oversee any contractors of CLIENT or their work or to provide the means, methods or sequence of their work or to stop their work. STRATEGIC INDUSTRY's work and/or presence at a site shall not relieve others of their responsibility to CLIENT or to others. STRATEGIC INDUSTRY shall not be liable for the failure of CLIENT's contractors or others to fulfill their responsibilities, and CLIENT agrees to indemnify, hold harmless and defend STRATEGIC INDUSTRY against any claims arising out of such failures.

### **Article 3: Responsibilities of CLIENT**

3.1 CLIENT, without cost to STRATEGIC INDUSTRY, shall:

(a) Designate a contact person with authority to make decisions for CLIENT regarding the Work and provide STRATEGIC INDUSTRY with information sufficient to contact such person in an emergency. If such representative cannot be reached, any request for work received from a person located at CLIENT's premises will be deemed authorized by CLIENT, and STRATEGIC INDUSTRY will, in its discretion, act accordingly.;

(b) Provide or arrange for reasonable access and make all provisions for STRATEGIC INDUSTRY to enter any site where Work is to be performed;

(c) Permit STRATEGIC INDUSTRY to control and/or operate all facility controls, systems, apparatus, equipment and machinery necessary to perform the Work;

(d) Furnish STRATEGIC INDUSTRY with all available information pertinent to the Work;

(e) Furnish STRATEGIC INDUSTRY with all approvals, permits and consents from government authorities and others as may be required for performance of the Work except for those STRATEGIC INDUSTRY has expressly agreed in writing to obtain;

(f) Notify STRATEGIC INDUSTRY promptly of any site conditions requiring special care, and provide STRATEGIC INDUSTRY with any available documents describing the quantity, nature, location and extent of such conditions;

(g) Comply with all laws and provide any notices required to be given to any government authorities in connection with the Work, except such notices STRATEGIC INDUSTRY has expressly agreed in writing to give;

(h) Provide STRATEGIC INDUSTRY with Material Safety Data Sheets that conform to OSHA requirements related to all Hazardous Materials located at the site;

(i) Furnish to STRATEGIC INDUSTRY any contingency plans related to the site; and

(j) Furnish the specified operating environment, including without limitation, suitable, clean, stable, properly conditioned electrical power to all Equipment; telephone lines, capacity and connectivity as required by such Equipment; and heat, light, air conditioning and other utilities in accordance with the specifications for the Equipment.

3.2 CLIENT acknowledges that the technical and pricing information contained in this Agreement is confidential and proprietary to STRATEGIC INDUSTRY and agrees not to disclose it or otherwise make it available to others without STRATEGIC INDUSTRY's express written consent.

3.3 CLIENT acknowledges that it is now and shall at all times remain in control of the project site. Except as expressly provided herein, STRATEGIC INDUSTRY shall not be responsible for the adequacy of the health or safety programs or precautions related to CLIENT's activities or operations, CLIENT's other contractors, the work of any other person or entity, or CLIENT's site conditions. STRATEGIC INDUSTRY is not responsible for inspecting, observing, reporting or correcting health or safety conditions or deficiencies of CLIENT or others at CLIENT's site. So as not to discourage STRATEGIC INDUSTRY from voluntarily addressing health or safety issues at CLIENT's site, in the event STRATEGIC INDUSTRY does address such issues by making observations, reports, suggestions or otherwise, STRATEGIC INDUSTRY shall not be liable or responsible on account thereof.

3.4 CLIENT is solely responsible for any removal, replacement or refinishing of the building structure or finishes that may be required to gain access to the Work.

3.5 CLIENT shall properly dispose of all ballasts, mercury bulb thermostats, used oil, contaminated filters, contaminated absorbents, refrigerant and any other Hazardous Materials that at any time are present at CLIENT's premises, in accordance with all applicable federal, state, and local laws, regulations, and ordinances.

### **Article 4: Changes; Delays; Excused Performance**

4.1 As the Work is performed, conditions may change or circumstances outside STRATEGIC INDUSTRY's reasonable control (including changes of law) may develop which would require STRATEGIC INDUSTRY to expend additional costs, effort or time to complete the Work, in which case STRATEGIC INDUSTRY will notify CLIENT and an equitable adjustment will be made to STRATEGIC INDUSTRY's compensation and time for performance. In the event conditions or circumstances require the Work to be suspended or terminated, STRATEGIC INDUSTRY shall be compensated for Work performed and for costs reasonable incurred in connection with the suspension or termination.

4.2 STRATEGIC INDUSTRY shall not be responsible for loss, delay, injury, damage or failure of performance that may be caused by circumstances beyond its control, including but not restricted to acts or omissions by CLIENT or its employees, agents or contractors, Acts of God, war, civil commotion, acts or omissions of government authorities, fire, theft, corrosion, flood, water damage, lightning, freeze-ups, strikes, lockouts, differences with workmen, riots, explosions, quarantine restrictions, delays in transportation, or shortage of vehicles, fuel, labor or materials. In the event of such delay or failure, the time for performance shall be extended by a period equal to the time lost plus a reasonable recovery period and the compensation shall be equitably adjusted for additional costs STRATEGIC INDUSTRY incurs due to such delay.

#### **Article 5: Compensation**

**5.1** Unless otherwise agreed in writing, STRATEGIC INDUSTRY shall be compensated for the Work at its prevailing rates and reimbursed for costs and expenses (plus reasonable profit and overhead) incurred in its performance of the Work.

**5.2** STRATEGIC INDUSTRY may invoice CLIENT on a monthly or other progress billing basis. Invoices are due and payable upon receipt or as otherwise set forth in the Agreement. If any payment is not received when due, STRATEGIC INDUSTRY may deem CLIENT to be in breach hereof and may enforce any remedies available to it hereunder or at law, including without limitation, acceleration of payments and suspension or termination of the Work at any time and without notice and shall be entitled to compensation for the Work previously performed and for costs reasonably incurred in connection with the suspension or termination. Any amount not paid within sixty (60) days of the date due shall accrue interest from the date due, until paid, at the rate of ten percent (10%) per annum. CLIENT shall reimburse STRATEGIC INDUSTRY for STRATEGIC INDUSTRY' costs and expenses (including reasonable attorneys' and witnesses' fees) incurred for collection under this Agreement. In the event of a dispute by CLIENT regarding any portion or all of an invoiced amount, it shall notify STRATEGIC INDUSTRY in writing of the amount in dispute and the reason for its disagreement within 21 days of receipt of the invoice, the undisputed portion shall be paid when due, and interest on the disputed, unpaid portion shall accrue as aforesaid, from the date due until the date of payment, to the extent that such amounts are finally determined to be payable to STRATEGIC INDUSTRY.

**5.3** Except to the extent expressly agreed in writing, STRATEGIC INDUSTRY' fees do not include any taxes, excises, fees, duties or other government charges related to the Work, and CLIENT shall pay such amounts or reimburse STRATEGIC INDUSTRY for any amounts it pays. If CLIENT claims a tax exemption or direct payment permit, it shall provide STRATEGIC INDUSTRY with a valid exemption certificate or permit and indemnify, defend and hold STRATEGIC INDUSTRY harmless from any taxes, costs and penalties arising out of same.

#### **Article 6: Warranty, Insurance and Allocation of Risk**

**6.1** (a) Until one year from either the date the Equipment is installed or the date of first beneficial use, whichever first occurs, all Equipment manufactured by STRATEGIC INDUSTRY or bearing its nameplate will be free from defects in material and workmanship arising from normal use and service.

(b) Labor for all Services under this Agreement is warranted to be free from defects for one year after the earlier of the date the Services are substantially completed or the date of first beneficial use.

(c) Equipment will not fail to function because of errors in processing, providing or receiving date or time data involving dates between January 1, 1999 and March 31, 2001, provided other products and software, including the computer workstation, with which the system interacts properly exchange date and time data with the system.

**6.2** (a) The limited warranties set forth in Section 6.1 will be void as to, and shall not apply to, any Work (i) repaired, altered or improperly installed by any person other than STRATEGIC INDUSTRY or its authorized representative; (ii) subjected to unreasonable or improper use or storage, used beyond rated conditions, operated other than per STRATEGIC INDUSTRY' or the manufacturer's instructions, or otherwise subjected to improper maintenance, negligence or accident; (iii) damaged because of any use of the Work after CLIENT has, or should have, knowledge of any defect in the Work; or (iv) Equipment not manufactured, fabricated and assembled by STRATEGIC INDUSTRY or not bearing STRATEGIC INDUSTRY' nameplate. However, STRATEGIC INDUSTRY assigns to CLIENT, without recourse, any and all assignable warranties available from any manufacturer, supplier, or subcontractor of such Equipment and will assist CLIENT in enforcement of such assigned warranties.

(b) Any claim under the limited warranty granted above must be made in writing to STRATEGIC INDUSTRY within thirty (30) days after discovery of the claimed defect, or with respect only to the warranty set forth in Subsection 4.1(c) prior to April 1, 2001, unless discovered directly by STRATEGIC INDUSTRY. Such limited warranty only extends to CLIENT and not to any subsequent owner of the Equipment. CLIENT's sole and exclusive remedy for any Equipment or Services not conforming with this limited warranty is limited to, at STRATEGIC INDUSTRY' option, (i) repair or replacement of defective components of covered Equipment, or (ii) re-performance of the defective portion of the Services, or (iii) to the extent previously paid, the issuance of a credit or refund for the original purchase price of such defective component or portion of the Equipment or Services.

(c) STRATEGIC INDUSTRY shall not be required to repair or replace more than the component(s) of the Equipment actually found to be defective. STRATEGIC INDUSTRY' warranty liability shall not exceed the purchase price of such item. Repaired or replaced Equipment will be warranted hereunder only for the remaining portion of the original warranty period.

**6.3** THE EXPRESS LIMITED WARRANTIES PROVIDED ABOVE ARE IN LIEU OF AND EXCLUDE ALL OTHER WARRANTIES, STATUTORY, EXPRESS, OR IMPLIED, INCLUDING WITHOUT LIMITATION ANY WARRANTY OF MERCHANTABILITY OR FITNESS FOR A PARTICULAR PURPOSE, WHICH ARE HEREBY EXPRESSLY DISCLAIMED. STRATEGIC INDUSTRY MAKES NO WARRANTY, EXPRESS OR IMPLIED, THAT ANY EQUIPMENT PROVIDED HEREUNDER WILL PREVENT ANY LOSS, OR WILL IN ALL CASES PROVIDE THE PROTECTION FOR WHICH IT IS INSTALLED OR INTENDED. THE LIMITED EXPRESS WARRANTIES AND REPRESENTATIONS SET FORTH IN THIS AGREEMENT MAY ONLY BE MODIFIED OR SUPPLEMENTED IN A WRITING SIGNED BY A DULY AUTHORIZED CORPORATE OFFICER OF STRATEGIC INDUSTRY.

**6.4** STRATEGIC INDUSTRY shall maintain the following insurance while performing the Work:

Workers' Compensation Statutory

Employers' Liability \$1,000,000 each accident

Commercial General Liability \$1,000,000 per occurrence and \$5,000,000 in the aggregate

Automobile Liability \$1,000,000 per occurrence/aggregate

**6.5** Risk of loss of materials and Equipment furnished by STRATEGIC INDUSTRY shall pass to CLIENT upon delivery to CLIENT's premises, and CLIENT shall be responsible for protecting and insuring them against theft and damage. However, until STRATEGIC INDUSTRY is paid in full, STRATEGIC INDUSTRY shall retain title for security purposes only and the right to repossess the materials and Equipment.

**6.6** STRATEGIC INDUSTRY will indemnify CLIENT from and against losses, claims, expenses and damages (including reasonable attorney's fees) for personal injury or physical damage to property, but not loss of use of the property resulting from such damage or from damage to any work performed hereunder. Such indemnification shall be solely to the extent caused by or arising directly from STRATEGIC INDUSTRY' or its employees', consultants' or agents' negligent acts or omissions or willful misconduct in connection with its performance of Services hereunder. STRATEGIC INDUSTRY' obligations under this indemnity provision shall not extend to claims, losses, expenses and damages arising out of or in any way attributable to the negligence of CLIENT or its agents, consultants or employees other than STRATEGIC INDUSTRY. STRATEGIC INDUSTRY' liability to CLIENT or any third party under this Section 6.6 or otherwise under the Agreement is expressly limited to, and STRATEGIC INDUSTRY shall not be liable other than for the direct losses, claims, expenses and damages arising as aforesaid. Neither party shall in any event be responsible under this Agreement for incidental, consequential, punitive, exemplary or special damages, including without limitation lost profits and/or lost business opportunities, whether arising in warranty, late or non-delivery of any Work, tort, contract or strict liability, and regardless of whether STRATEGIC INDUSTRY has been advised of the possibility of such damages. STRATEGIC INDUSTRY reserves the right to control the defense and settlement of any claim for which STRATEGIC INDUSTRY has an obligation to indemnify hereunder. The parties acknowledge that the price which STRATEGIC INDUSTRY has agreed to perform its Work and obligations under this Agreement is calculated based upon the foregoing limitations of liability, and that STRATEGIC INDUSTRY has expressly relied on, and would not have entered into this Agreement but for such limitations of liability.

#### **Article 7: Hazardous Materials Provisions**

**7.1** The Work does not include directly or indirectly performing or arranging for the detection, monitoring, handling, storage, removal, transportation, disposal or treatment of Oil or Hazardous Materials. Except as disclosed pursuant to Section 7.3, CLIENT represents that there is no asbestos or any other hazardous or toxic materials, as defined in the Comprehensive Environmental Response, Compensation and Liability Act of 1980, as amended, the regulations promulgated there under, and other applicable federal, state or local law ("Hazardous Materials"), present at CLIENT's locations where Services are performed. STRATEGIC INDUSTRY will notify CLIENT immediately if it discovers or suspects the presence of any Hazardous Material. All Services have been priced and agreed to by STRATEGIC INDUSTRY in reliance on CLIENT's representations as set forth in this Section 7.1. The presence of Hazardous Materials constitutes a change in the Proposed Solution equivalent to a change order whose terms must be agreed to by STRATEGIC INDUSTRY before its obligations hereunder will continue.

**7.2** CLIENT shall be solely responsible for testing, abating, encapsulating, removing, remedying or neutralizing such Hazardous Materials, and for the costs thereof. Even if an appropriate change order has been entered into pursuant to Section 7.1 above, STRATEGIC INDUSTRY will continue to have the right to stop providing Services until the job site is free from Hazardous Materials. In such event, STRATEGIC INDUSTRY will receive an equitable extension of time to complete its Services, and compensation for delays caused by Hazardous Materials remediation. In no event shall STRATEGIC INDUSTRY be required or construed to take title, ownership or responsibility for such Oil or Hazardous Materials. CLIENT shall sign any required waste manifests in conformance with all government regulations, listing CLIENT as the generator of the waste.

**7.3** CLIENT warrants that, prior to the execution of the Agreement, it has notified STRATEGIC INDUSTRY in writing of any and all Hazardous Materials present, potentially present or likely to become present at CLIENT's locations and has provided a copy of any jobsite safety policies, including but not limited to lock-out and tag procedures, laboratory procedures, chemical hygiene plan, material safety data sheets or other items covered or required to be disclosed or maintained by federal, state, or local laws, regulations or ordinances.

PROJECT:	_____
CATALOG #:	_____
FIXTURE TYPE:	_____
NOTES:	_____

# ALW Area Light Wave Series

ALW Medium



ALW Large



Images are shown for illustration purposes only.

The ALW Area Light Wave Series Gen 1 features an exclusive housing design that complements each environment. This modern luminaire is offered in medium and large sizes with lumen packages between 10,400 to 56,000 lumens. Boasting an advanced heatsink and leading surge protection, this luminaire also provides superior light distribution, visual comfort, and uniformity in its optical design. Spec-grade optics coming soon.



## APPLICATIONS

Auto Dealerships, Parking Lots, Walkways, Roadways, and other Public Areas, etc.



## SPECIFICATIONS

### CONSTRUCTION

Manufactured die-cast aluminum housing includes advanced thermal design and housing that is completely sealed against moisture and environmental contaminants. Low profile, compact design carries 3G vibration rating per ANSI C136.31.

### AMBIENT TEMPERATURE

Suitable for use in -40°C to 45°C (-40°F to 113°F)

### MOUNTING

Mounting options include Square and Round Pole Mount, Wall Mount, Trunnion Mount, and Adjustable Slipfitter Mount. Optional photocell is installed to the luminaire by default.

### LUMEN OUTPUT

Lumen packages ranging from 10,400 to 56,000 lumens

### CCT AND CRI

3000K, 4000K and 5000K CCT available; 70CRI  
Dark Sky Friendly - 3000K option only with no uplight

### OPTICS

Precision molded optics provides superior distribution, minimal light trespass, and application spacing. Available in Type III, IV, and V light distributions. Spec-grade optics coming soon.

### WARRANTY

10-year limited warranty. 1-year labor warranty. Comprehensive warranty terms can be located on [www.slgus.com](http://www.slgus.com).

### ELECTRICAL

Standard 120-277V. Optional HVU 277V/480V. Standard 1-10V Dimming. Class II Driver 50/60Hz with open/short circuit protection. 5KV/10KA (120-277V), 10KV/20KA (277-480V) Surge protector per ANSI/IEEE C62.41.2.

### FINISH

Standard Polyester Powder Dark Bronze finish. Optional Silver Gray and White finishes available. Custom finishes available.

### CERTIFICATIONS

UL Listed for wet locations. Equivalent to IP65 rating. FCC compliant. RoHs compliant. DesignLights Consortium® (DLC) Premium 5.1 qualified product. Not all versions of this product may be DLC qualified. Please visit [www.slgus.com](http://www.slgus.com) to confirm which versions are qualified.

## MOUNTING & OPTIONS



AL-SPAR



AL-WMB



AL-SFD



AL-SFD-P1



AL-T



PC-1



MS-FSP-211



L3/L7



ALW-M-EGS/ALW-LEGS

### ORDERING GUIDE

EXAMPLE: ALW 150 T3 G1 50K

Luminaire Type	Lumen Output	Dist. Type	Generation	Voltage	CCT	Finish	Mount	Options (Pre-Installed)
<b>ALW</b> Wave Area Light Medium	<b>100</b> 10,400 Lumens	<b>T3=</b> Type III <b>T4=</b> Type IV <b>T5=</b> Type V	<b>G1</b>	<b>BLANK=</b> 120-277V <b>HVU=</b> 277-480V	<b>3K*</b> 3000K <b>4K</b> 4000K <b>5K</b> 5000K	<b>BLANK=</b> Dark Bronze <b>SG=</b> Silver Gray <b>W=</b> White <b>C**=</b> Custom	<b>AL-SPAR=</b> Square and Round Pole Mount <b>AL-WMB=</b> Wall Mount <b>AL-SFD=</b> Slipfitter Mount <b>AL-SFD-P1=</b> Slipfitter Mount with PC-1 <b>AL-T=</b> Trunnion Mount	<b>PC-1=</b> Twist-lock Photocell (120-277V) <b>PC-2=</b> Twist-lock Photocell (480V) <b>PC-3=</b> 7-Pin receptacle <b>MS-FSP-211=</b> Motion Sensor 120-277V (Choose 1) <b>L3=</b> 2x Lens (Max 20ft Mounting Height) <b>L7=</b> 2.5x Lens (Max 40ft Mounting Height) <b>MS-FSP-221B=</b> Motion Sensor 347-480V† (Choose 1) <b>L3=</b> 2x Lens (Max 20ft Mounting Height) <b>L7=</b> 2.5x Lens (Max 40ft Mounting Height) <b>MS-LPS-202-L3=</b> PIR Motion Sensor with 360° L3 Lens, Max 40ft mounting height <b>MS-FSIR-100=</b> Wireless commissioning tool <b>ALW-M-EGS=</b> External Glare Shield for Medium Wave Area Light, Dark Bronze <b>ALW-L-EGS=</b> External Glare Shield for Large Wave Area Light, Dark Bronze
	<b>150</b> 14,200 Lumens							
	<b>210</b> 21,200 Lumens							
	<b>280</b> 28,000 Lumens							
<b>340</b> 34,000 Lumens								
<b>ALW</b> Wave Area Light Large	<b>430</b> 42,500 Lumens							
	<b>510</b> 51,000 Lumens							

\*Special Order CCT. May require longer lead time.

\*\*For a custom color, please call to place your order.

†Requires 1 MS-FSIR-100 per jobsite.

### ADVANCED WIRELESS CONTROL

**AVI-LVFA-1CH-12-24VDC-OA** 12V DC Single Channel, Bluetooth Controller, Outdoor (Check compatibility)

**AVI-LVFA-1CH-12-24VDC-OA-DC** 12V DC Single Channel, Bluetooth Controller, Outdoor with Sensor (Check compatibility)

**AVI-IFAC-5A-OA** Bluetooth Controller with Relay, Outdoor (Check compatibility)

**DIM10-087-FW** 12VDC Single Channel, Cloud Based Controller (Check compatibility)

## RECOMMENDED REPLACEMENT & MOUNTING HEIGHT

Wattage	Lumen Range	Equivalence	Mounting Height
70W	10,400 – 10,600	150W MH	15-20'
100W	14,200 – 14,800	250W MH	15-20'
150W	21,200 – 22,200	400W MH	20-30'
200W	28,000 – 28,800	400W MH	20-30'
240W	34,000 – 35,500	750W MH	25-50'
300W	42,500 – 43,700	1000W MH	25-50'
350W	50,000 – 51,000	1000W MH	25-50'
380W	53,000 – 56,000	1000W MH	25-50'

OPTIONS & ACCESSORIES



**MS-FSP-211**  
Dimmable Motion Sensor



**MS-FSP-L3/L7**  
Lens

The **MS-FSP-211** provides multi-level control base on motion and daylight level. IP66 rated when mounted inside the fixture. Requires L3 or L7 lens depending on the mounting height.

Operation Voltage	Shape	Adjustable Time Delay	Fade Down Time	Operating Temperature	Mounting Height For MS-FSP-L3	Mounting Height For MS-FSP-L7
120/277V	Cone	30 sec - 30 min Default 15 min	0-10 sec	-40°F to 158°F (-40°C to 70°C)	Max 20 ft*	Max 40 ft**

\* Covers a 40 ft diameter when mounting height is 20 ft. Coverage is equal to 2x the height.  
\*\* Covers a 100 ft diameter when mounting height is 40 ft. Coverage is equal to 2.5x the height



**MS-FSP-221B**  
Dimmable Motion Sensor



**MS-FSP-L3/L7**  
Lens



**MS-FSIR-100**  
Wireless Commissioning Tool for MS-FSP-221B

The **MS-FSP-221B** provides multi-level control base on motion and daylight level. IP66 rated when mounted inside the fixture. Requires L3 or L7 lens depending on the mounting height.

Operation Voltage	Shape	Adjustable Time Delay	Fade Down Time	Operating Temperature	Mounting Height For MS-FSP-L3	Mounting Height For MS-FSP-L7
Single Phase 100-347VAC  Phase to Phase 208/230/480VAC	Cone	30 sec / 1-30 min Default 5 min	0-60 sec	-40°F to 167°F (-40°C to 75°C)	Max 20 ft*	Max 40 ft**

\* Covers a 40 ft diameter when mounting height is 20 ft. Coverage is equal to 2x the height.  
\*\* Covers a 100 ft diameter when mounting height is 40 ft. Coverage is equal to 2.5x the height



Twist-lock Photocell

- PC-1:** 120-277V On/Off Twist-lock Photocell
- PC-347:** 347V On/Off Twist-lock Photocell
- PC-480:** 480V On/Off Twist-lock Photocell

MOUNTING



AL-SPAR



AL-WMB



AL-SFD



AL-SFD-P1



AL-T

## DIMENSIONS

### MEDIUM

70W, 100W, 150W, 200W  
Slipfitter Mount

**WEIGHT: 13.25 LB**

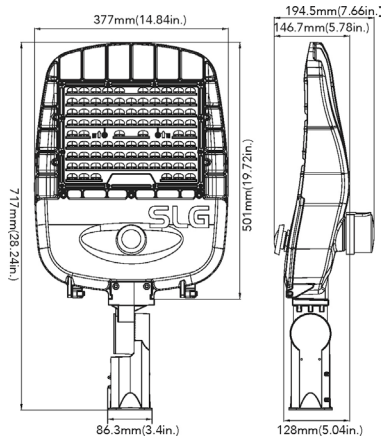

### MEDIUM

70W, 100W, 150W, 200W  
Pole Mount

**WEIGHT: 13.25 LB**

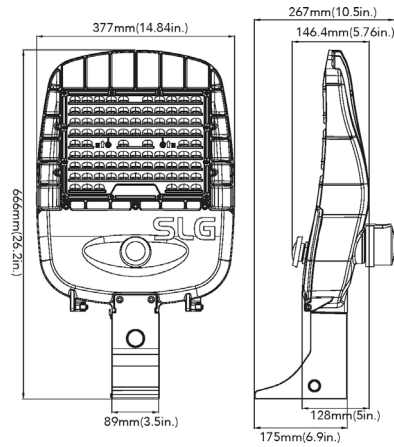

### LARGE

240W, 300W, 350W, 380W  
Slipfitter Mount

**WEIGHT: 20.95 LB**

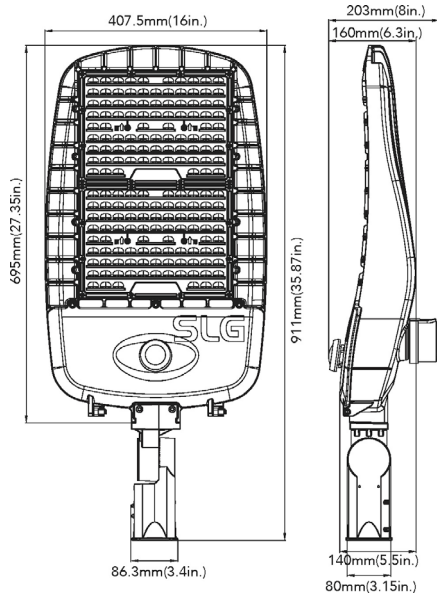

### LARGE

240W, 300W, 350W, 380W  
Pole Mount

**WEIGHT: 20.95 LB**

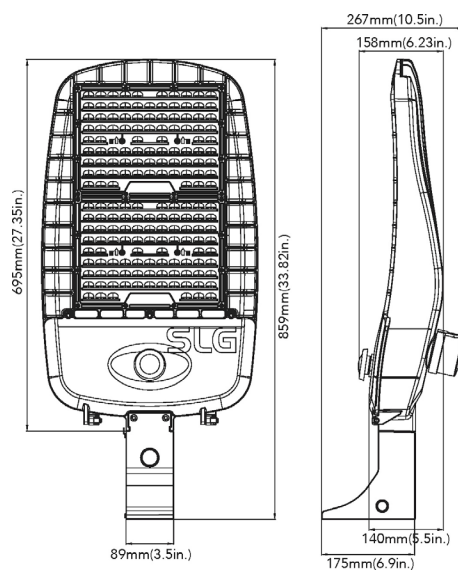

## MOUNTING DIMENSIONS

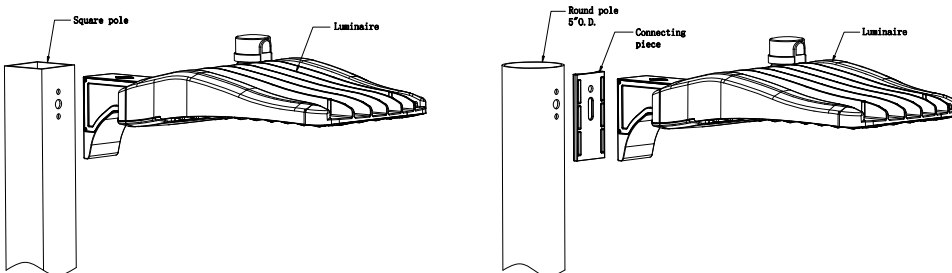

## DRILLING TEMPLATE

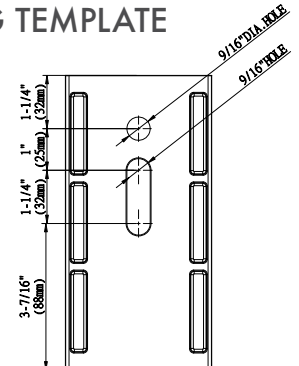



PERFORMANCE COMPARISON

Product Number	Wattage	Voltage	Dist. Type	3000K CCT					4000K CCT					5000K CCT				
				Lumen	B	U	G	Efficacy	Lumen	B	U	G	Efficacy	Lumen	B	U	G	Efficacy
ALW 100	70W	120-277V	Type III	10,250	2	0	2	146	10,400	2	0	2	149	10,400	2	0	2	149
			Type IV	10,250	1	0	3	146	10,400	1	0	3	149	10,400	1	0	3	149
			Type V	10,450	3	0	3	149	10,600	3	0	3	151	10,600	3	0	3	151
		277-480V	Type III	10,250	2	0	2	146	10,400	2	0	2	149	10,400	2	0	2	149
			Type IV	10,250	1	0	3	146	10,400	1	0	3	149	10,400	1	0	3	149
			Type V	10,450	3	0	3	149	10,600	3	0	3	151	10,600	3	0	3	151
ALW 150	100W	120-277V	Type III	14,000	2	0	2	140	14,200	2	0	2	142	14,200	2	0	2	142
			Type IV	14,000	3	0	4	140	14,200	3	0	4	142	14,200	3	0	4	142
			Type V	14,500	4	0	4	145	14,800	4	0	4	148	14,800	4	0	4	148
		277-480V	Type III	14,000	2	0	2	140	14,200	2	0	2	142	14,200	2	0	2	142
			Type IV	14,000	3	0	4	140	14,200	3	0	4	142	14,200	3	0	4	142
			Type V	14,500	4	0	4	145	14,800	4	0	4	148	14,800	4	0	4	148
ALW 210	150W	120-277V	Type III	21,000	3	0	3	140	21,200	3	0	3	141	21,200	3	0	3	141
			Type IV	21,000	3	0	4	140	21,200	3	0	4	141	21,200	3	0	4	141
			Type V	22,000	4	0	4	147	22,200	4	0	4	148	22,200	4	0	4	148
		277-480V	Type III	21,000	3	0	3	140	21,200	3	0	3	141	21,200	3	0	3	141
			Type IV	21,000	3	0	4	140	21,200	3	0	4	141	21,200	3	0	4	141
			Type V	22,000	4	0	4	147	22,200	4	0	4	148	22,200	4	0	4	148
ALW 280	200W	120-277V	Type III	28,000	4	0	3	140	28,000	4	0	3	140	28,000	4	0	3	140
			Type IV	28,000	3	0	4	140	28,000	3	0	4	140	28,000	3	0	4	140
			Type V	28,500	5	0	5	143	28,800	5	0	5	144	28,800	5	0	5	144
		277-480V	Type III	28,000	4	0	3	140	28,000	4	0	3	140	28,000	4	0	3	140
			Type IV	28,000	3	0	4	140	28,000	3	0	4	140	28,000	3	0	4	140
			Type V	28,500	5	0	5	143	28,800	5	0	5	144	28,800	5	0	5	144
ALW 340	240W	120-277V	Type III	33,500	3	0	4	140	34,000	3	0	4	142	34,000	3	0	4	142
			Type IV	33,500	3	0	5	140	34,000	3	0	5	142	34,000	3	0	5	142
			Type V	35,000	5	0	5	146	35,500	5	0	5	148	35,500	5	0	5	148
		277-480V	Type III	33,500	3	0	4	140	34,000	3	0	4	142	34,000	3	0	4	142
			Type IV	33,500	3	0	5	140	34,000	3	0	5	142	34,000	3	0	5	142
			Type V	35,000	5	0	5	146	35,500	5	0	5	148	35,500	5	0	5	148
ALW 430	300W	120-277V	Type III	42,000	3	0	4	140	42,500	3	0	4	142	42,500	3	0	4	142
			Type IV	42,000	4	0	4	140	42,500	4	0	4	142	42,500	4	0	4	142
			Type V	43,500	5	0	5	145	43,700	5	0	5	146	43,700	5	0	5	146
		277-480V	Type III	42,000	3	0	4	140	42,500	3	0	4	142	42,500	3	0	4	142
			Type IV	42,000	4	0	4	140	42,500	4	0	4	142	42,500	4	0	4	142
			Type V	43,500	5	0	5	145	43,700	5	0	5	146	43,700	5	0	5	146
ALW 510*	380W	120-277V	Type III	52,500	3	0	5	138	53,000	3	0	5	139	53,000	3	0	5	139
			Type IV	52,500	3	0	5	138	53,000	3	0	5	139	53,000	3	0	5	139
			Type V	55,500	5	0	5	146	56,000	5	0	5	147	56,000	5	0	5	147
	350W	277-480V	Type III	49,500	3	0	5	141	50,000	3	0	5	143	50,000	3	0	5	143
			Type IV	49,500	3	0	5	141	50,000	3	0	5	143	50,000	3	0	5	143
			Type V	50,500	5	0	5	144	51,000	5	0	5	146	51,000	5	0	5	146

\*Different wattage between 120-277V and HVU 347-480V

### EPA OF AREA LIGHT

<b>M</b>	70W	0.6299	1.232	1.493	1.259	1.861	2.095	1.861
	100W							
	150W							
	200W							
<b>L</b>	240W	0.8062	1.458	1.842	1.612	2.264	2.494	2.264
	300W							
	350W							
	380W							

### ELECTRICAL LOAD

Wattage	Current (A)					
	120V	208V	240V	277V	347V	480V
70W	0.58	0.34	0.29	0.25	0.20	0.15
100W	0.83	0.48	0.42	0.36	0.29	0.21
150W	1.25	0.72	0.63	0.54	0.43	0.31
200W	1.66	0.96	0.83	0.72	0.58	0.42
240W	2.0	1.15	1.0	0.87	0.69	0.50
300W	2.5	1.44	1.25	1.08	0.87	0.63
350W	—	—	—	—	1.01	0.73
380W	3.17	1.83	1.58	1.37	—	—

### LUMEN AMBIENT TEMPERATURE (LAT) MULTIPLIERS

Ambient		Lumen Multiplier
0°C	32°F	1.02
10°C	50°F	1.01
20°C	68°F	1.00
25°C	77°F	1.00
30°C	86°F	0.98
40°C	104°F	0.98

### PROJECTED LUMINAIRE MAINTENANCE

Ambient Temperature	OPERATING HOURS				Calculated L70 (Hours)
	0	25,000	50,000	100,000	
25°C / 77°F	1	0.95	0.91	0.81	>214,973

PHOTOMETRIC

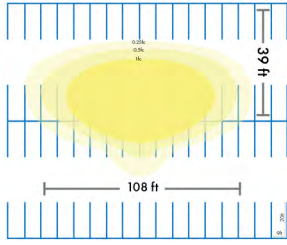

70W Type III - 20ft

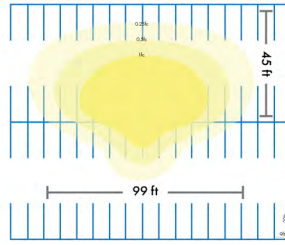

70W Type IV - 20ft

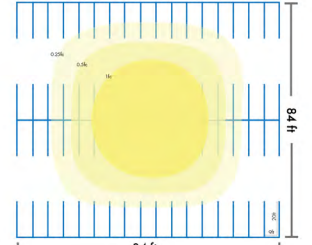

70W Type V - 20ft

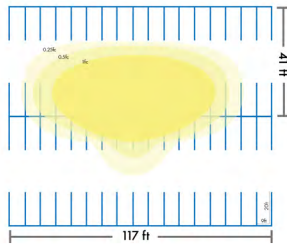

100W Type III - 20ft

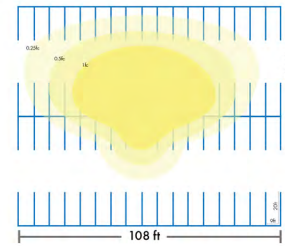

100W Type IV - 20ft

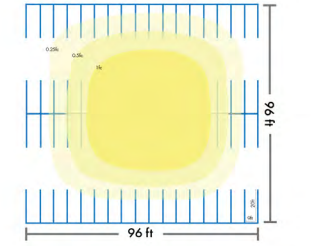

100W Type V - 20ft

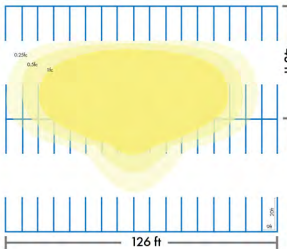

150W Type III - 20ft

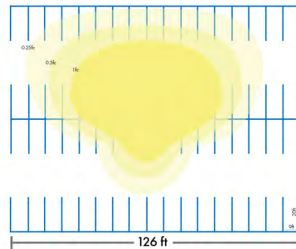

150W Type IV - 20ft

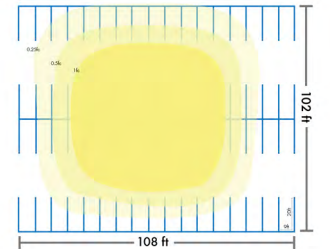

150W Type V - 20ft

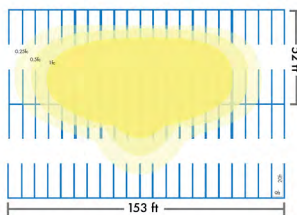

200W Type III - 25ft

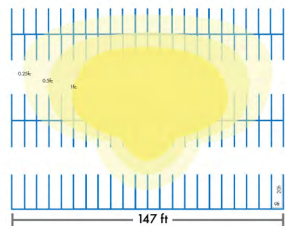

200W Type IV - 25ft

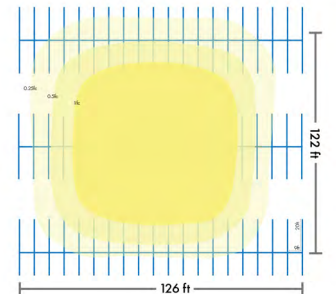

200W Type V - 25ft

# PHOTOMETRIC

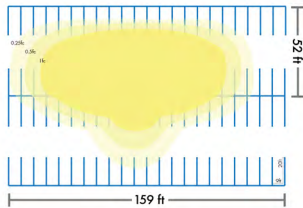

240W Type III - 25ft

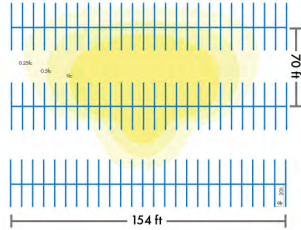

240W Type IV - 25ft

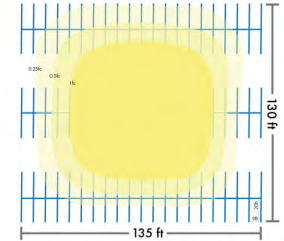

240W Type V - 25ft

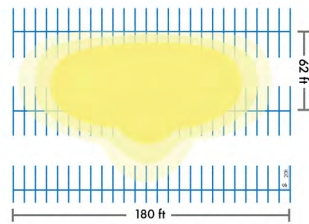

300W Type III - 30ft

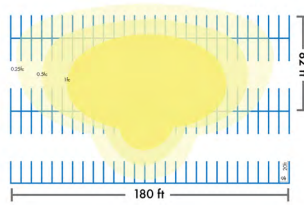

300W Type IV - 30ft

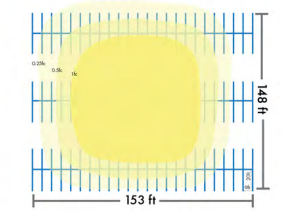

300W Type V - 30ft

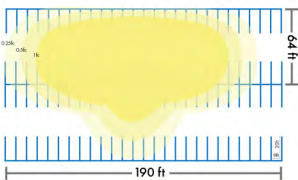

380W Type III - 30ft

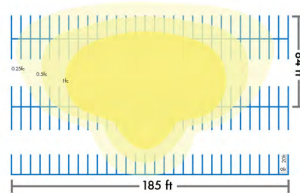

380W Type IV - 30ft

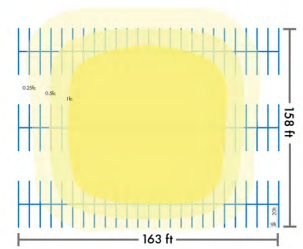

380W Type V - 30ft